

8 MONITOR MENU

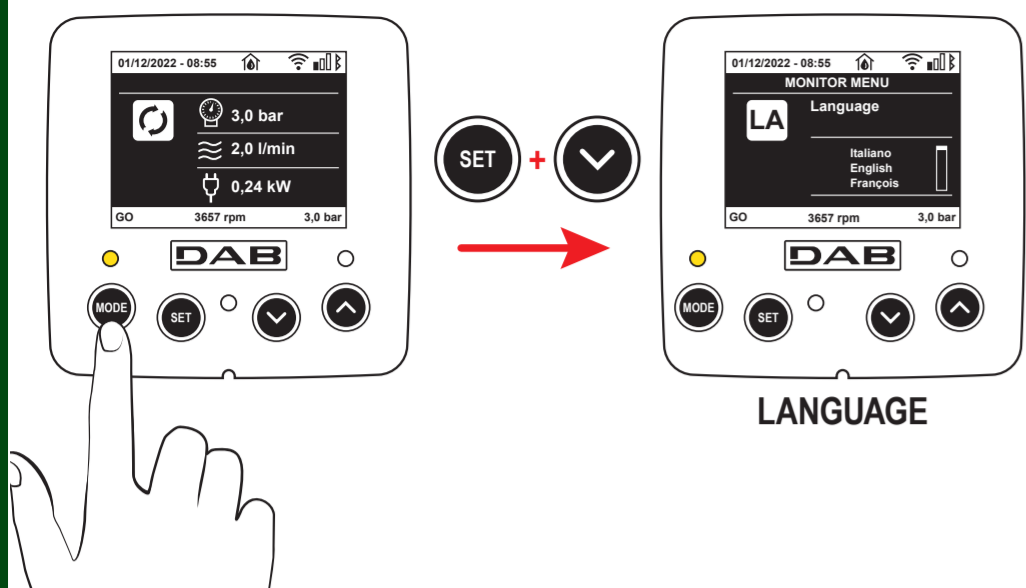

9 PUMP ENABLE / DISABLE

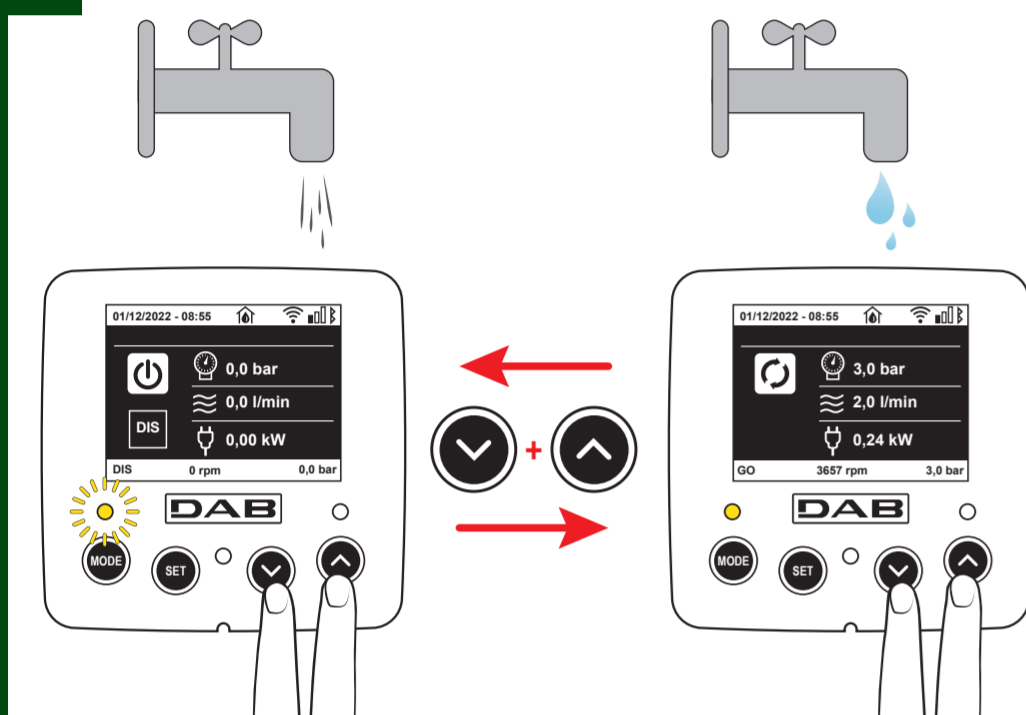

10 SET POINT

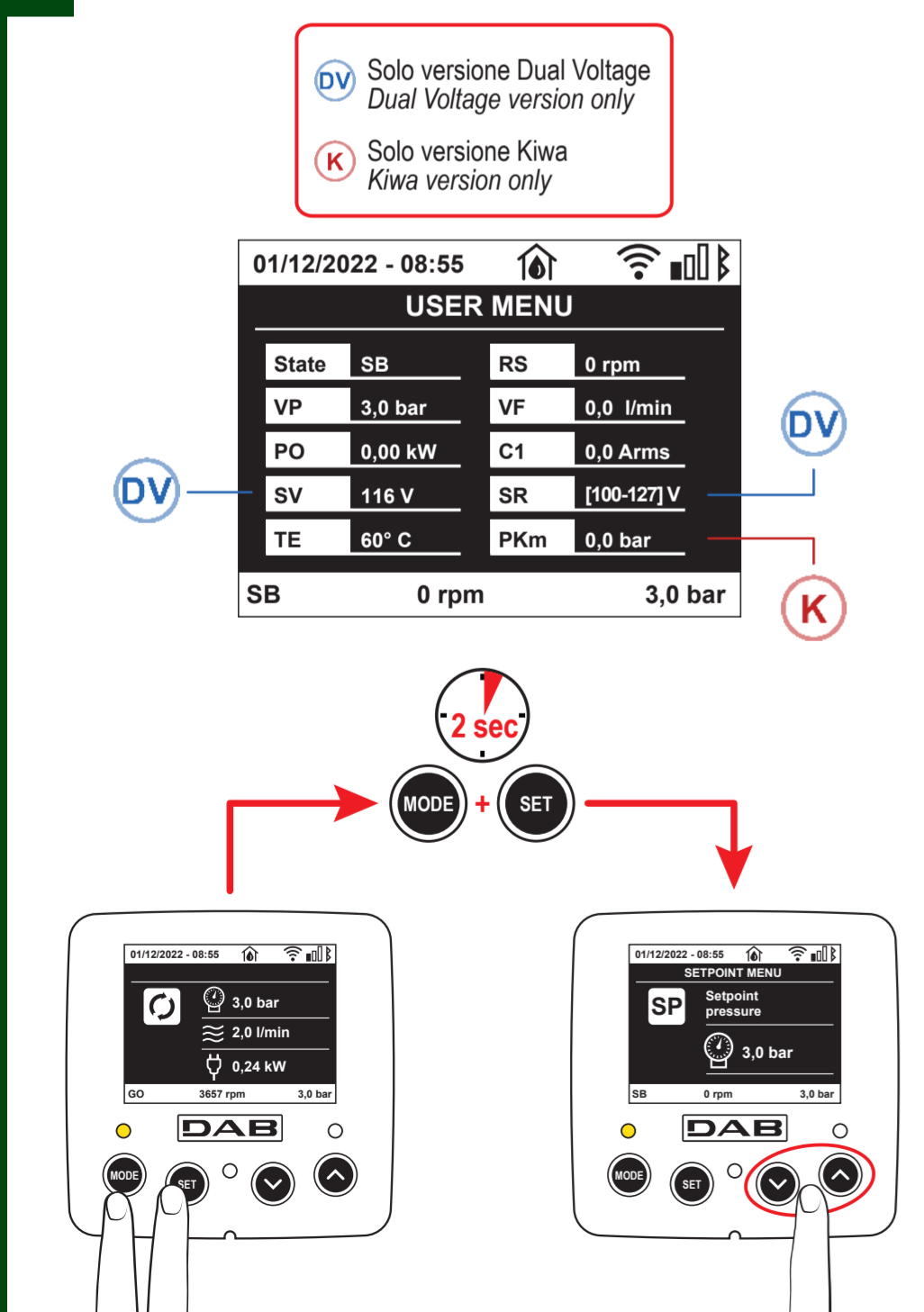

11 GROUP OF PUMPS

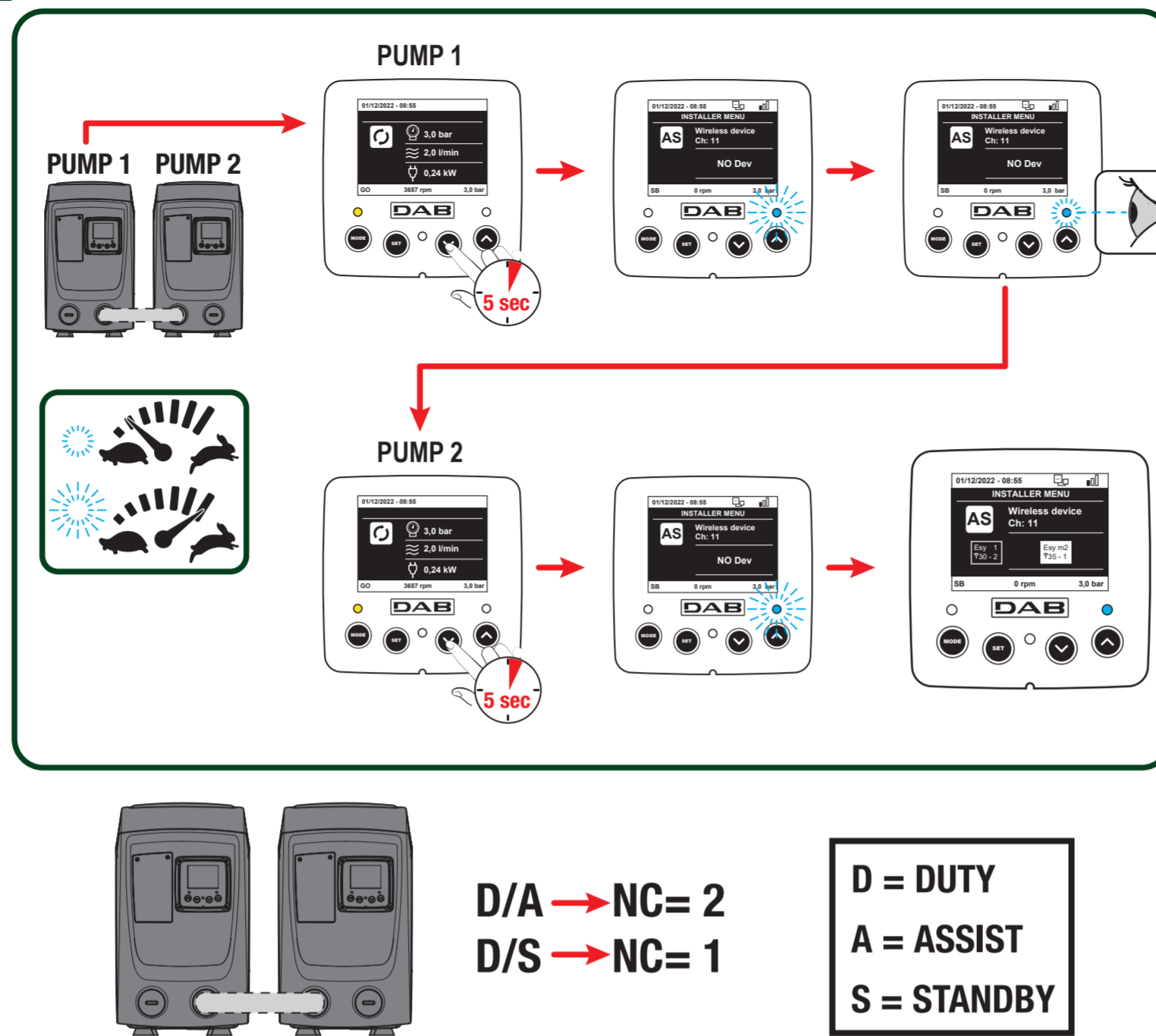

14

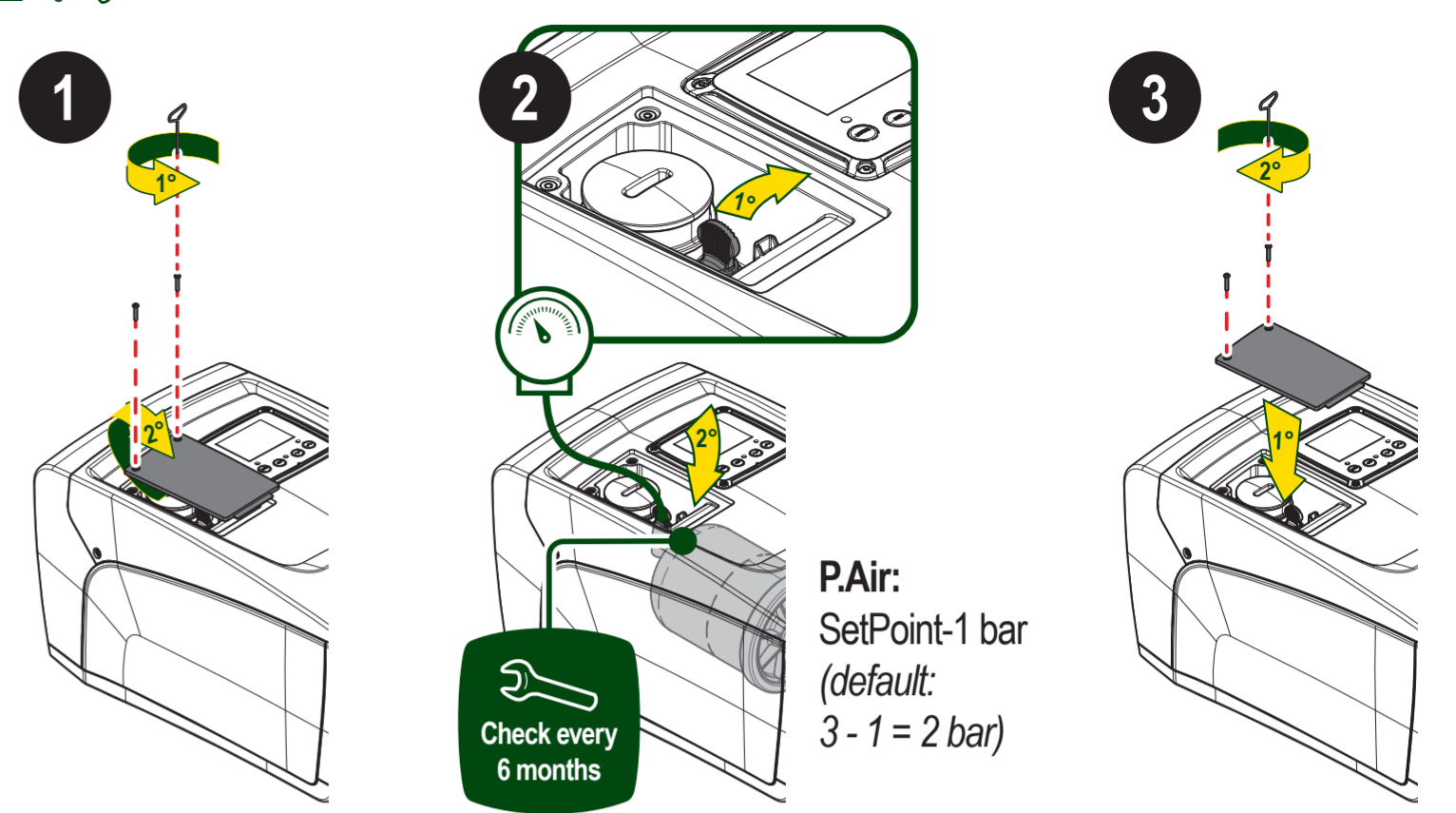

15

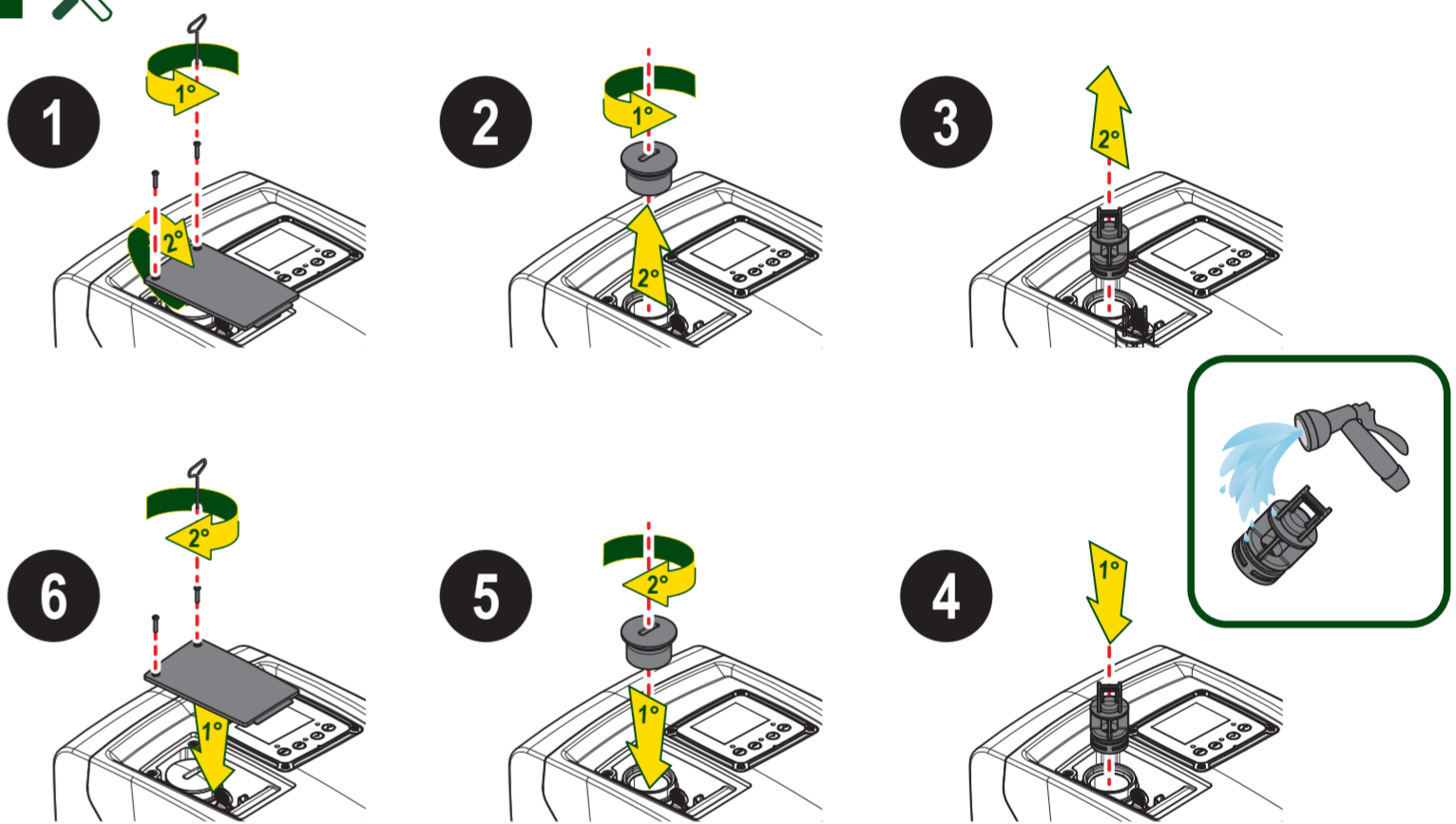

12 DCONNECT



13 ANTICYCLING

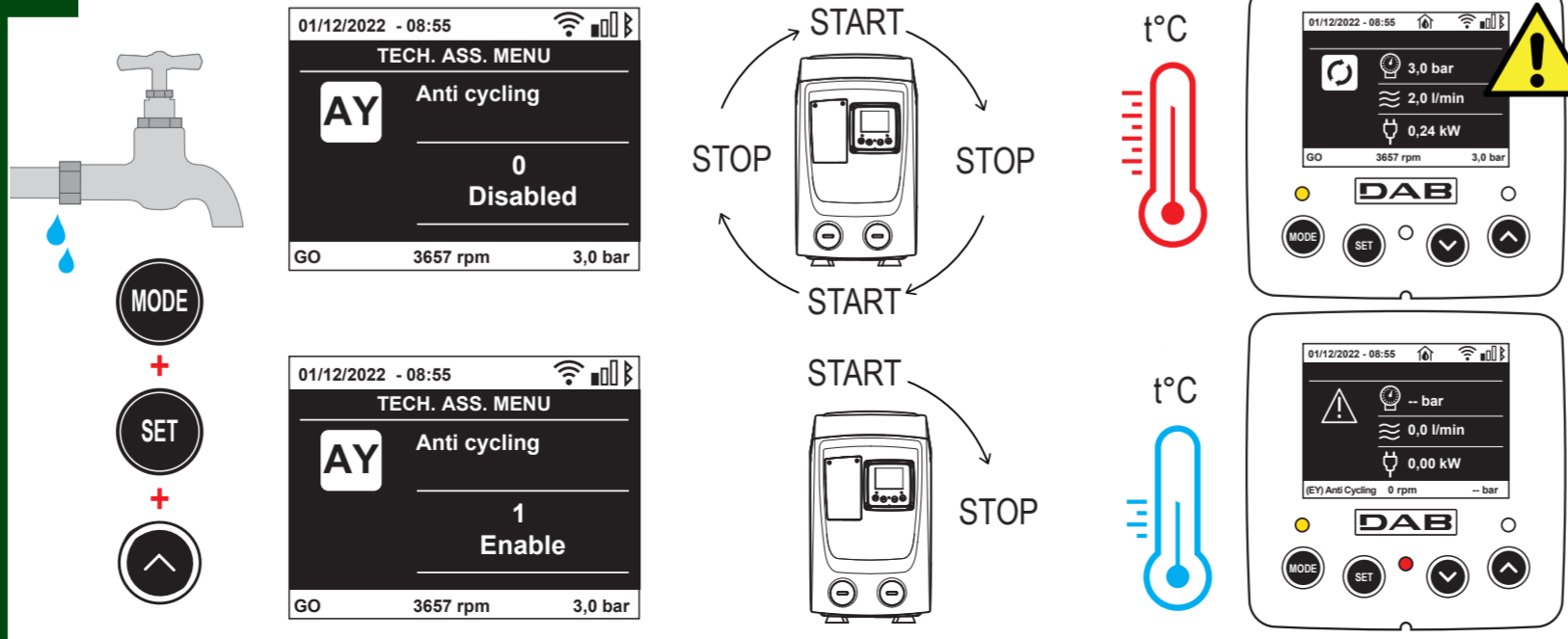

16

